



Jetmaster reserves the right to alter specifications, scope of supply and model line up without prior notification

# AMESTI RONDO 490

CONVECTION & RADIATED HEAT

*Imported*

Transform any corner into a cozy retreat with the Amesti Round 490. Designed for perfect corner installations, this Chilean-crafted unit boasts a smooth, heavy-duty outer body and heat-efficient vermiculite inner boards. Its compact, rounded design adds a touch of modern elegance while delivering powerful warmth. Complete with a poker and installation manual, the Amesti Round 490 is as easy to set up as it is to enjoy. Bring style, efficiency, and comfort to any space with this standout fireplace.



UNIT /MODEL	MEASUREMENTS (MM)					ROUND FLUE	
	Body Width	Depth	Body Height	Kw	M <sup>2</sup>	Ø	Length
RONDO 490	600	490	930	15	190	150	1200

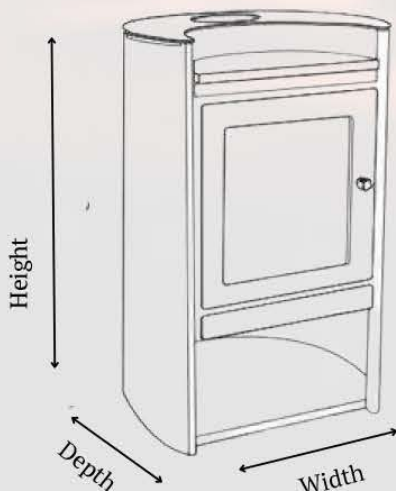



Jetmaster reserves the right to alter specifications, scope of supply and model line up without prior notification



# AMESTI SCANTEK

CONVECTION & RADIATED HEAT

*Imported*

Imported from Chile, the Amesti Scantek combines sleek design with heavy-duty durability, offering a stunning centerpiece for any space. Its smooth, robust exterior and vermiculite-lined interior maximize heat retention for a cozy, efficient burn. Complete with a poker and installation manual, this thoughtfully crafted unit is as easy to set up as it is to enjoy. Designed without a grate for simplified use, the Amesti Scantek brings an authentic warmth and effortless charm, perfect for those seeking both style and substance in their home



UNIT / MODEL	MEASUREMENTS (MM)					ROUND FLUE	
	Body Width	Depth	Body Height	Kw	M <sup>2</sup>	Ø	Length
SCANTEK 380	470	500	780	10	120	150	1200

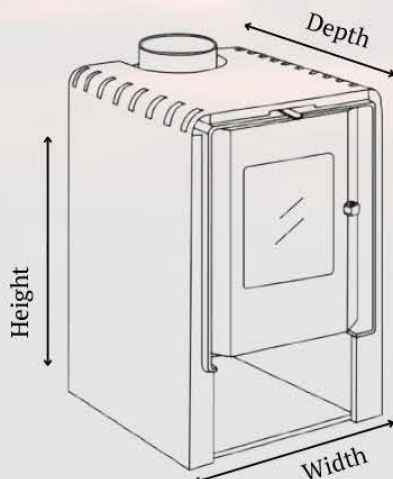



Jetmaster reserves the right to alter specifications, scope of supply and model line up without prior notification



# DAMPER UNIT

RADIATED HEAT ONLY

## Brick Fireplace Installation

Our high-quality damper units are designed specifically for brick fireplace and braai installations, ensuring an efficient and effective operation. Constructed with a heavy-duty outer body, these units provide exceptional durability and longevity, making them a reliable choice for any setup. The damper control allows for a clean and smooth draw, optimizing airflow for a better fire experience. With the ability to adjust the flow, our damper units enhance combustion efficiency, reducing smoke and maximising heat.



UNIT / MODEL	MEASUREMENTS (MM)								RECTANGULAR FLUE		ROUND FLUE	
	A	B	C	D	E	F	G	H	Width	Breadth	Ø	Length
600	200	150	150	200	100	650	350	550	200	200	225	1200
700 S	200	200	200	200	100	750	400	600	200	200	225	1200
850	200	250	250	300	100	900	450	650	200	300	275	1200
1050	200	300	300	400	100	1100	500	700	200	400	325	1200
1200	350	150	300	500	100	1250	500	700	350	500	475	1200
1500	350	150	300	500	100	1550	500	700	350	500	475	1200

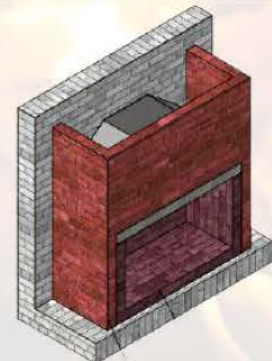
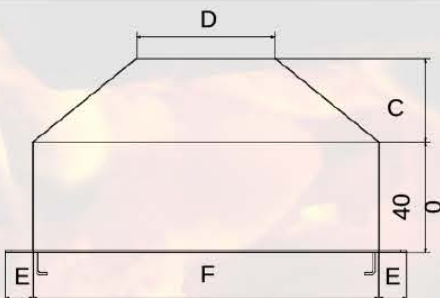



Jetmaster reserves the right to alter specifications, scope of supply and model line up without prior notification

# FIRESCAPE RANGE

CONVECTION & RADIATED HEAT

*Freestanding*

The Firescape Range is a beautifully designed fireplace, perfect for those seeking both elegance and powerful heating. With its large glass front, it provides a mesmerising view of the flames, creating a warm and inviting atmosphere. Built with a heavy-duty outer body and smooth finish, the Firescape also features vermiculite inner boards for optimal heat retention. The freestanding model comes complete with a convenient log box, while the built-in model offers a sleek, streamlined look. This fireplace is crafted to deliver impressive warmth, making it an exceptional addition to any space. Grate options are not required for use.



UNIT / MODEL	MEASUREMENTS (MM)					ROUND FLUE	
	Body Width	Depth	Body Height	Kw	M <sup>2</sup>	Ø	Length
1060 FIRESCAPE	1085	461	585	17	260	150	1200
LOG BOX	1085	461	402				
1060 DOUBLE SIDED	1085	581	587	17	260	175	1200
LOG BOX	1085	581	402				

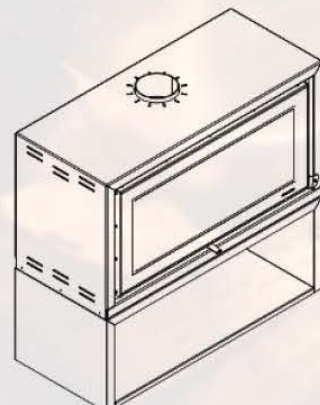
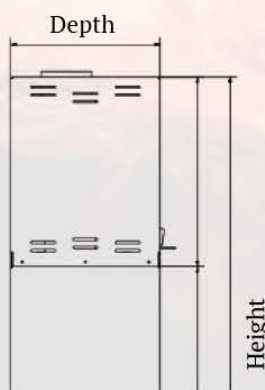
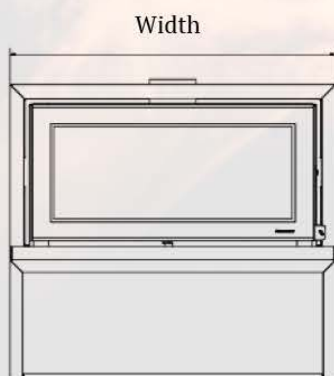



Jetmaster reserves the right to alter specifications, scope of supply and model line up without prior notification



# HEX

CONVECTION & RADIATED HEAT

*Freestanding*

The Hex Range Fireplace is a standout piece with its eye-catching hexagonal design that brings modern flair to any home. Crafted with a heavy-duty outer body, it includes 4.2 meters of mild steel flue pipes, an escutcheon plate, a rotating cowl, a poker, and an installation manual for easy setup.

Choose from versatile grate options—basket grate and pan, log pan, or deluxe gas grate—to customize your heating experience. Elevate your living space with the unique charm and practicality of the Hex Range!



UNIT / MODEL	MEASUREMENTS (MM)			WOOD		GAS		HEX FLUE (6 SIZES)			
	Body Width	Depth	Body Height	Basket grate	M <sup>2</sup>	DLX Grate	M <sup>2</sup>	Side Panel Length	Corner to Corner	Flat Side to Flat Side	Length
800	806	706	1123	500	68	600	24	100	203	177	4200
900	900	780	1199	600d	72	700	40	120	244	212	4200
1000	998	863	1317	700d	90	none	none	150	293	255	4200

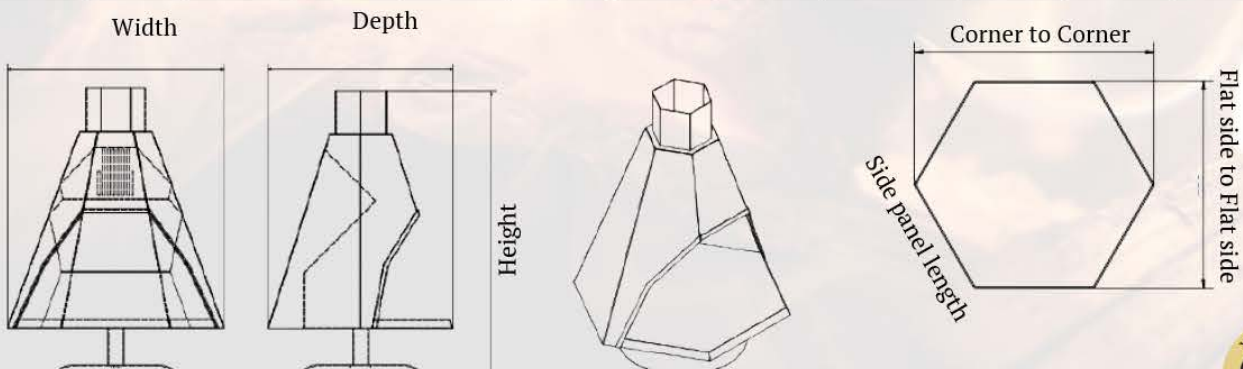

**MASTER**  
FIREPLACES

6 Larch Nook,  
Zwartkop Ext. 4, Centurion

082 477 6505  
www.masterfireplaces.co.za



Excludes Corrosion



Jetmaster reserves the right to alter specifications, scope of supply and model line up without prior notification



# KALAHARI BOMA

RADIATED HEAT ONLY

## Outdoor Boma Collection

The Kalahari 2 in 1 Firebasket, designed to bring warmth and ambiance to your outdoor gatherings. Featuring a robust heavy-duty steel body with interlocking segments, this firebasket offers exceptional strength and stability.

Equipped with a nickel-plated grill, the Kalahari enhances both functionality and aesthetics, providing a durable surface for cooking and grilling. The included ash pan base plate simplifies cleanup, allowing you to enjoy your fire without the worry of residue.



UNIT / MODEL	MEASUREMENTS (MM)		
	Width	Height	Base
2 IN 1 BOMA	477x477	452	500x500

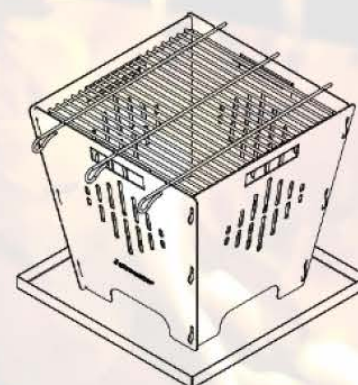
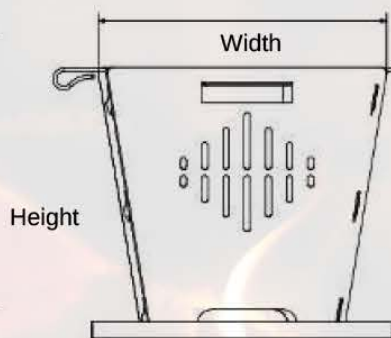
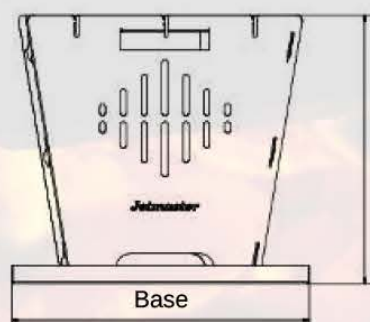



Jetmaster reserves the right to alter specifications, scope of supply and model line up without prior notification

# LYNX

CONVECTION & RADIATED HEAT

*Freestanding*

The Lynx Fireplace features a unique design that enhances any corner or serves as a striking centerpiece in your living space. Its heavy-duty outer body ensures durability, while the included 4.2 meters of mild steel flue pipes, escutcheon plate, rotating cowl, poker, and installation manual make setup a breeze.

With multiple grate options—basket grate and pan, log pan, or standard gas grate—the Lynx offers versatility to meet your heating needs, providing both warmth and elegance in your home.



UNIT / MODEL	MEASUREMENTS (MM)			WOOD		GAS		FLUE	
	Body Width	Depth	Body Height	Basket grate	M <sup>2</sup>	DLX Grate	M <sup>2</sup>	Size	Length
850	878	420	1165	600 d	68	500	24	225 x 165	4200

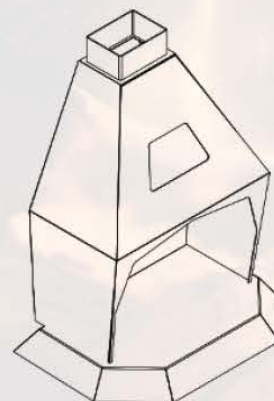
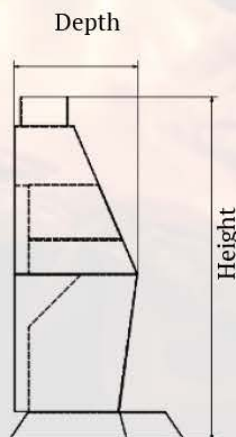
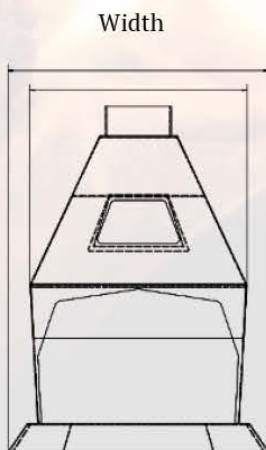

# MASTER

## FIREPLACES



Jetmaster reserves the right to alter specifications, scope of supply and model line up without prior notification

## MAKOYA STOVE

RADIATED HEAT ONLY

*Freestanding Stove*

The Makoya Stove is a robust agricultural stove designed to be both practical and efficient. Perfect for outdoor or well-ventilated areas, it's a versatile solution for cooking meals and providing warmth to small spaces. With its durable design and simple functionality, the Makoya Stove is ideal for farmhouses, workshops, or rural setups. Built to last, it combines traditional cooking methods with modern reliability, making it a dependable choice for your daily needs. Cook, heat, and live the Makoya way!



UNIT / MODEL	MEASUREMENTS (MM)							ROUND FLUE(MM)		
	Body Width	Body Depth	Body Height	Base Width	Base Depth	Base Height	Kw	M <sup>2</sup>	Ø	Length
MAKOYA	600	300	400	650	346	252	5	50	125	600

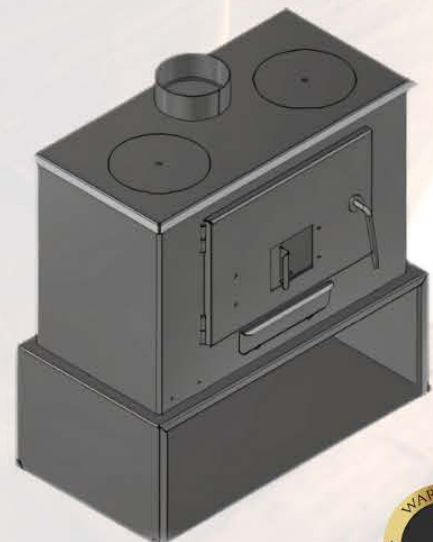
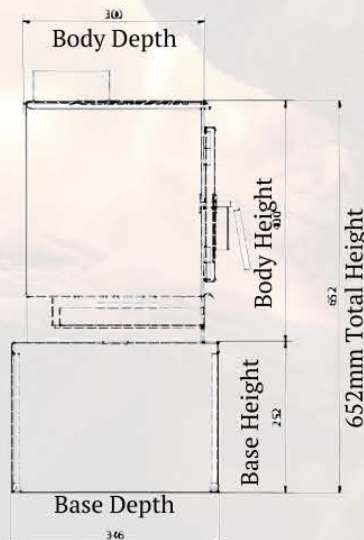
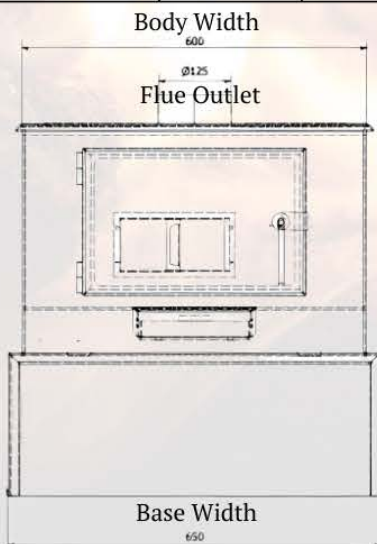





Jetmaster reserves the right to alter specifications, scope of supply and model line up without prior notification

# MYNX

RADIATED HEAT ONLY

*Freestanding*

The Mynx Range is the perfect entry-level fireplace for those seeking reliable performance and timeless style without the premium price. Despite its accessible price point, the Mynx is crafted with a heavy-duty outer body and comes equipped with everything needed for a seamless installation—three 1.2-meter mild steel flue pipes, an escutcheon plate, storm cowl, poker, and detailed installation manual. With options for a log and ash pan grate or a standard gas grate, the Mynx Range combines flexibility and efficiency, making it a popular choice that delivers warmth and value to any space.



UNIT / MODEL	MEASUREMENTS (MM)			WOOD		GAS		ROUND FLUE	
	Body Width	Depth	Body Height	Grate size	M <sup>2</sup>	STD Grate	M <sup>2</sup>	Ø	Length
MYNX 7-50	530	395	966	455x260	42	440	26	175	1200
MYNX 8-50	708	527	996	600x335	52	600	40	225	1200

Width

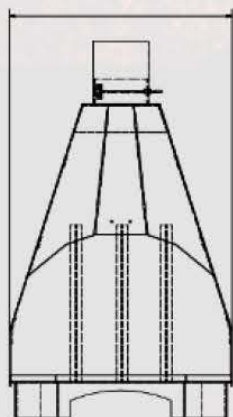

Depth

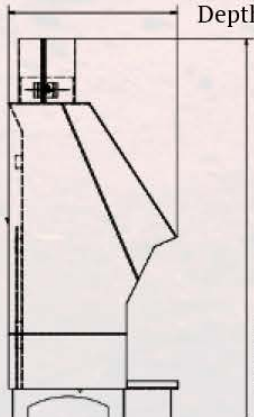

Height

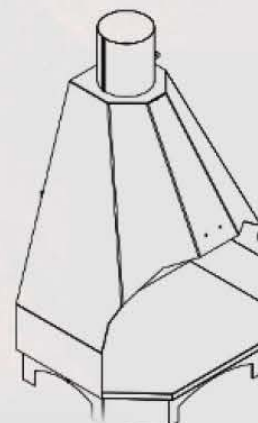

**MASTER**  
FIREPLACES

6 Larch Nook,  
Zwartkop Ext. 4, Centurion

082 477 6505  
www.masterfireplaces.co.za



Excludes Corrosion



Jetmaster reserves the right to alter specifications, scope of supply and model line up without prior notification



# ONYX 600

CONVECTION & RADIATED HEAT

*Freestanding*

The Onyx Fireplace is a stunning addition to any corner space, with its unique rounded body that adds a touch of elegance to any room. Designed for both beauty and functionality, the Onyx features a heavy-duty outer body and comes complete with everything needed for easy installation: three 1.2-meter mild steel flue pipes, an escutcheon plate, storm cowl, poker, and installation manual. Equipped with a round basket grate, this fireplace is perfect for creating a warm, inviting atmosphere in any home.



UNIT / MODEL	MEASUREMENTS (MM)					WOOD		ROUND FLUE	
	Body Diameter	Depth	Body Height	Base Height	Base Diameter	Grate size	M <sup>2</sup>	Ø	Length
600	600 Ø	510	852	335	850 Ø	446 Ø x165	53	225	1200

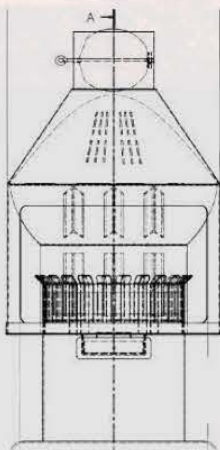

Body Diameter

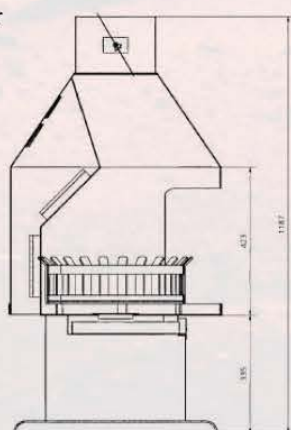

Depth

Height

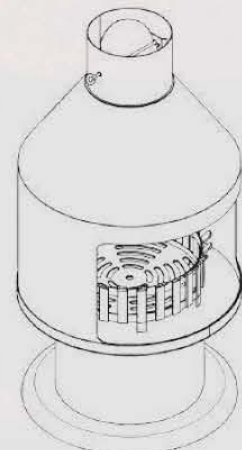



Jetmaster reserves the right to alter specifications, scope of supply and model line up without prior notification

# PHOENIX

CONVECTION & RADIATED HEAT

*Freestanding*

The Phoenix Range is a stunningly designed fireplace that seamlessly blends elegance with powerful heating performance. Its expansive glass front offers a captivating view of the flames, enhancing the ambiance with a warm and inviting glow. Constructed with a heavy-duty outer body and a sleek, smooth finish. The Phoenix features high-quality vermiculite inner boards for superior heat retention. The freestanding model includes a built-in log box for added convenience. Designed for exceptional warmth and style, this fireplace is a perfect addition to any space. No grate options are required for use.



UNIT / MODEL	MEASUREMENTS (MM)					ROUND FLUE	
	Body Width	Depth	Body Height	Kw	M <sup>2</sup>	Ø	Length
PHOENIX F/S	872	455	959	15	190	150	1200

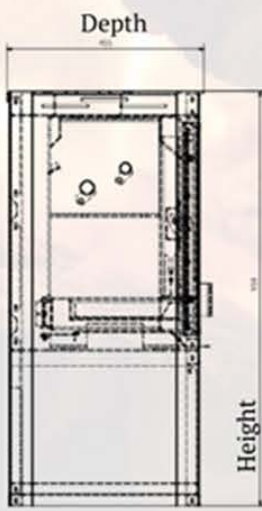
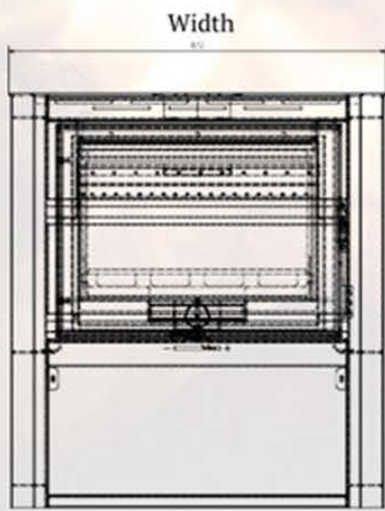



Jetmaster reserves the right to alter specifications, scope of supply and model line up without prior notification



# STAR RANGE

CONVECTION & RADIATED HEAT

*Freestanding*

Experience the epitome of elegance with the Jetmaster Star Range—a fireplace that combines luxury with functionality for the discerning homeowner. Crafted with a heavy-duty outer body and a smooth, sophisticated finish, the Star Range exudes timeless style. Its lightly sandblasted door adds a refined touch, while the vermiculite inner boards ensure optimal heat retention and durability. Featuring a removable ash pan, cast grid, and a convenient basket grate for anthracite (wood users don't need it), this fireplace makes maintenance a breeze. Complete with an installation manual and poker, the Jetmaster Star Range promises effortless warmth and ambiance for any living space



UNIT / MODEL	MEASUREMENTS (MM)					ROUND FLUE	
	Body Width	Depth	Body Height	Kw	M <sup>2</sup>	Ø	Length
RIGEL	714	402	662	7.6	100	150	1200
ADHARA	800	454	662	12	160	150	1200
VEGA	930	534	761	15	190	150	1200
DOUBLE-SIDED	800	525	525	7.6	100	150	1200

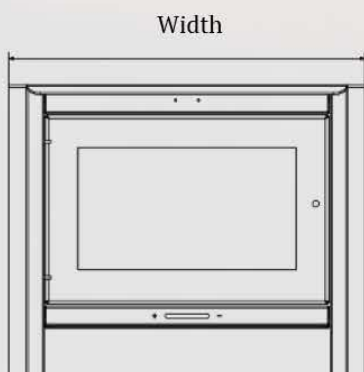

Width

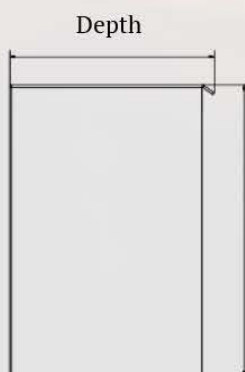

Depth

Height

