



Jetmaster reserves the right to alter specifications, scope of supply and model line up without prior notification



# 850 FREESTANDING

## *Freestanding*

850 Freestanding Braai, designed for durability and convenience. It features a sturdy outer body, charcoal tray, nickel-plated grill, potjie hook, and a slide-in door with a prep table for added functionality. The unit comes complete with a 1.2-meter flue pipe, rotating cowl, pedestal, and an installation manual. Available in 430, 304, or 316-grade stainless steel (on request), the 850 Freestanding Braai offers versatility and quality for an exceptional braai experience.



UNIT / MODEL	MEASUREMENTS (MM)								FLUE	
	Body Width	Depth	Body Height	Pedestal Height	Total Height	Pedestal Base	Grill size	Charcoal starter	SizeØ	Length
850	810	409	802	827	1629	567Ø	805X420	NO	275	1200

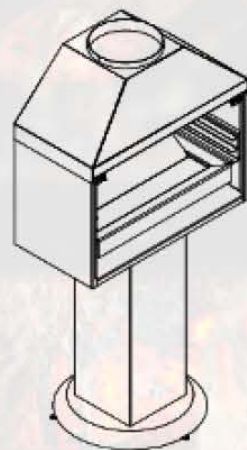
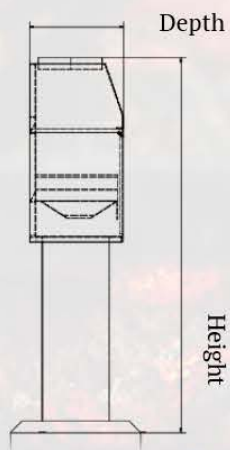
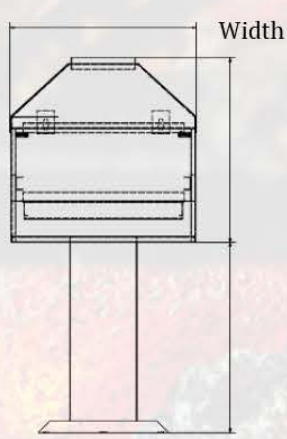



Jetmaster reserves the right to alter specifications, scope of supply and model line up without prior notification

# ARGENTINIAN

## *Freestanding / Insert*

Discover the Argentinian Asado, the mother of all barbecues, designed for slow cooking meat to succulent perfection while infusing it with the smoky flavours of South African hardwoods. Featuring a V-grid design, this grill cradles juices to create exquisite basting sauces and minimizes flare-ups. The Argentinian Asado includes drip trays, an ash disposal pan, and a rotisserie set, with an optional stand for added versatility. Born in South America and perfected in South Africa, this grill elevates your outdoor cooking to a new level of flavour and enjoyment.



UNIT / MODEL	MEASUREMENTS (MM)					
	Unit Width	Unit Depth	Unit Height	Stand Width	Stand Depth	Stand Height
ARGENTINIAN						
MEDIUM	946	500	540	1564	490	802
LARGE	1148	500	608	1899	490	755

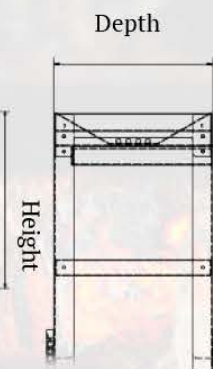
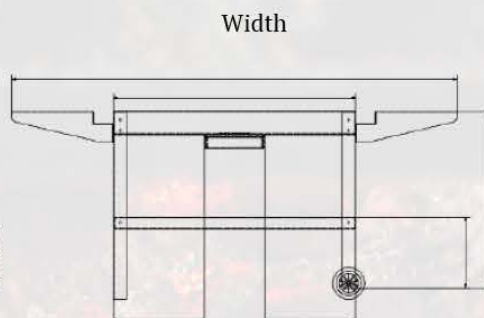
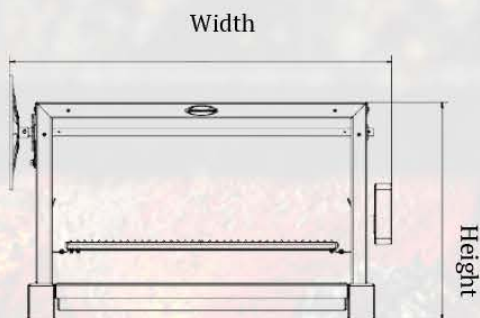



Jetmaster reserves the right to alter specifications, scope of supply and model line up without prior notification

# ATLANTA 4 BURNER

## *Gas Braai*

The Jetmaster 4 Burner Atlanta, a versatile grilling solution featuring four powerful burners and an additional side burner for ultimate cooking flexibility. Equipped with a warmer rack and convenient storage for your gas bottle, this braai makes grilling a breeze. Whether it's a weekday dinner or an adventurous weekend cookout, the Jetmaster 4 Burner Atlanta is designed for easy and everyday use, elevating your outdoor cooking experience to new heights!



UNIT / MODEL	MEASUREMENTS (MM)					
	Width	Depth	Height	Heat Output	Grill Size	Gas Cylinder Size
ATLANTA	1300	540	1110	17,1kW	650X375	9kg



Jetmaster reserves the right to alter specifications, scope of supply and model line up without prior notification

# CABINET 850

*Freestanding*

The Cabinet 850 Freestanding Braai is a high-quality, ready-to-use braai designed for effortless outdoor cooking. Built for convenience and durability, this unit eliminates the need for construction—simply place it in your outdoor space and start grilling!

Complete with a 600mm length of flue pipe and storm cowl



UNIT / MODEL	MEASUREMENTS (MM)							FLUE	
	Body Width	Depth	Body Height	Cabinet Height	Total Height	Grill size	Charcoal starter	SizeØ	Length
CABINET 850	807	471	800	727	1527	750x355	NO	275	600

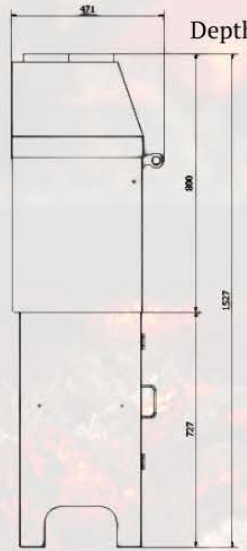
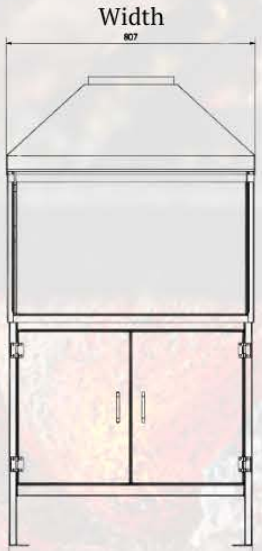



Jetmaster reserves the right to alter specifications, scope of supply and model line up without prior notification



# CAMP BRAAI

## Table top

The Camp Braai, designed for outdoor cooking enthusiasts. It features a sturdy outer body and comes with five kebab skewers for grilling delights. The rotisserie kit includes a motor powered by two size D batteries (not included), allowing for effortless cooking. Additionally, it includes a potjie pot stand suitable for a size 3 pot (pot not included) and an installation manual for easy setup. Experience the joy of outdoor cooking with the versatile Camp Braai, perfect for any camping adventure!



UNIT / MODEL	MEASUREMENTS (MM)			
	Width	Depth	Height	Grill Size
CAMP BRAAI	447	377	330	580X400

Different configurations

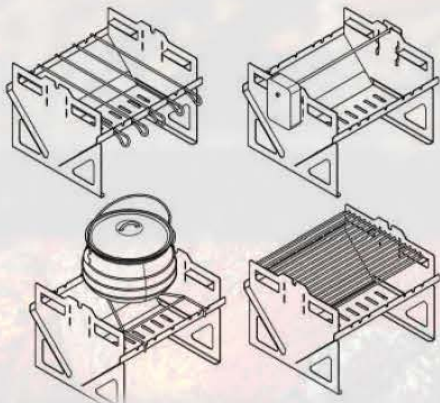

Flat pack

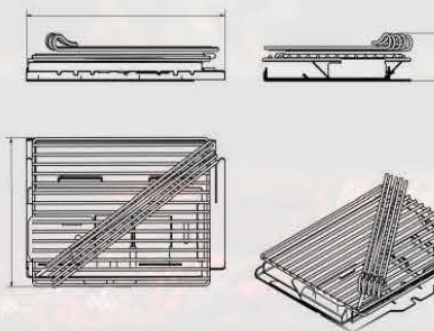

Width

Depth

Height

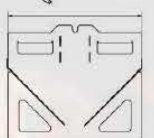
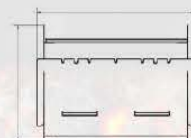

**MASTER**  
FIREPLACES

6 Larch Nook,  
Zwartkop Ext. 4, Centurion

082 477 6505  
www.masterfireplaces.co.za



Excludes Corrosion



Jetmaster reserves the right to alter specifications, scope of supply and model line up without prior notification



# CHARCOAL INSERT

*Table top insert*

The Jetmaster Tabletop Braai, your favorite built-in braai without the hassle of construction. Designed to fit perfectly on your existing tabletop or bricked braai, it offers all the benefits and features of a modern built-in unit. Enjoy the convenience and style of the Jetmaster Tabletop Braai, making every grilling experience effortless and enjoyable!



UNIT / MODEL	MEASUREMENTS (MM)				
	Width	Depth	Height	Grill Size	Charcoal starter
740	740	435	345	690x420	NO
1000	1000	435	370	785X420	YES
1000 OPT 2	1000	435	345	985X420	NO
1200	1200	435	370	985X420	YES

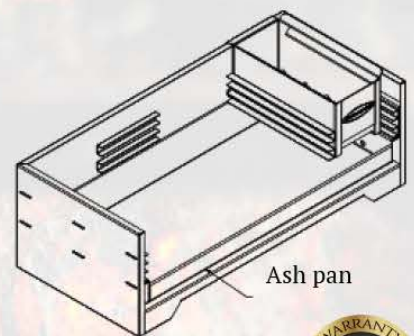
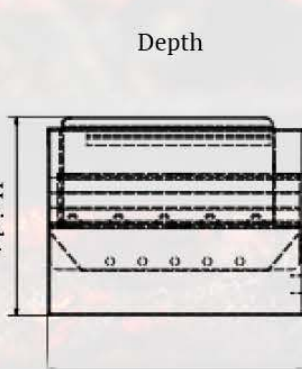
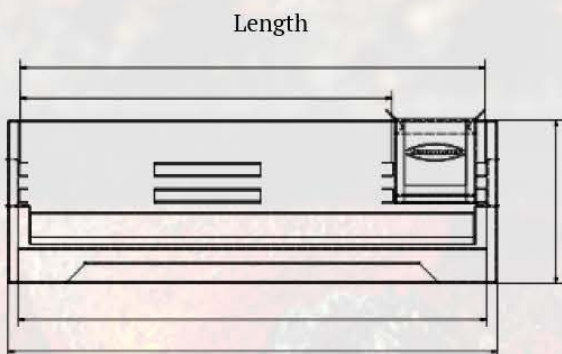



Jetmaster reserves the right to alter specifications, scope of supply and model line up without prior notification

# DIY BRAAIBOX

## Freestanding Box

BraaiBox is a sleek, freestanding cabinet designed for effortless outdoor grilling. Available in durable mild steel or a stylish powder-coated finish, it eliminates the need for complex construction—just insert your braai and get grilling. Whether you're upgrading your patio or need a simple solution for your braai setup, BraaiBox offers a no-fuss, high-quality option that blends functionality with modern design. Perfect for any outdoor space, BraaiBox ensures your braai is secure, stylish, and always ready for action.

**Please note that the BraaiBox does not come assembled!**  
**1 Length of 1.2 meter flue and Storm cowl included**



UNIT / MODEL	MEASUREMENTS (MM)					
	BRAAIBOX SUITABLE FOR	Complete Box Width	Complete Box Depth	Complete Box Height	Cabinet Width only	Cabinet Height only
1000 Entertainer	1286	520	1928	1270	850	215

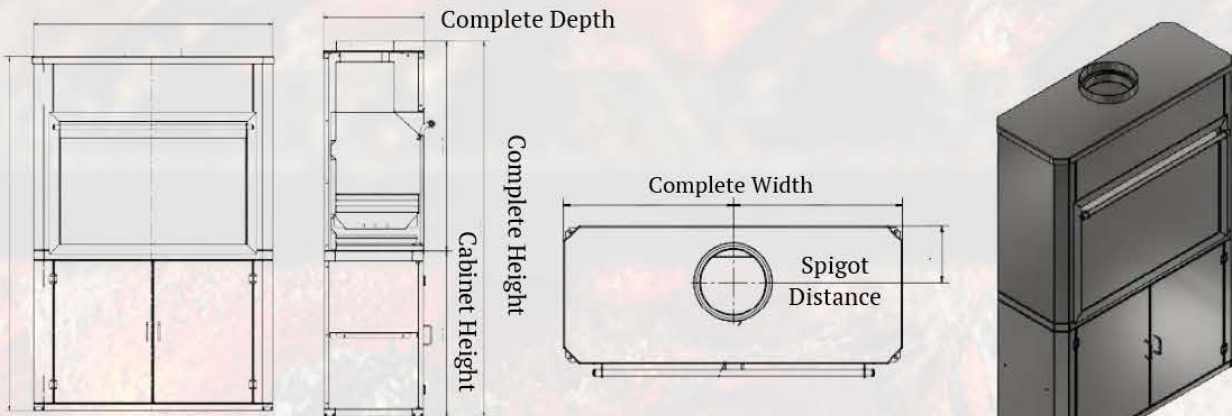



Jetmaster reserves the right to alter specifications, scope of supply and model line up without prior notification

# GAS INSERT

## Tabletop insert

The Gas Inserts, featuring a robust exterior crafted from 304 stainless steel for exceptional durability. Equipped with 304 stainless steel burners and deflector plates, the inserts include a copper pipe, orange hose, regulator, and an installation manual for easy setup. Choose between an insert or a tabletop version to suit your needs: the S-Shallow (insert option) or D-Deep (countertop option). Experience versatility and quality in your grilling with our Gas Inserts!



UNIT / MODEL	MEASUREMENTS (MM)			
	Width	Depth	Height	Grill Size
GAS GRILLS				
3 BNR S	645	415	202	635X285
3 BNR D	645	595	202	635X445
4 BNR S	805	415	202	795X285
4 BNR D	805	595	202	795X445
5 BNR S	983	415	202	973X285
6 BNR S	1165	415	202	1155X285
6 BNR D	1165	595	202	1155X445

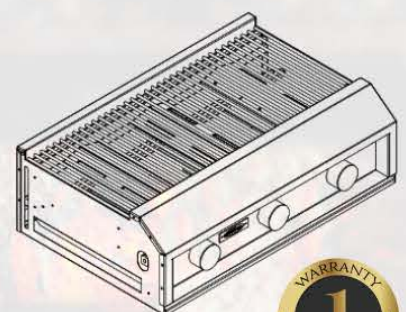
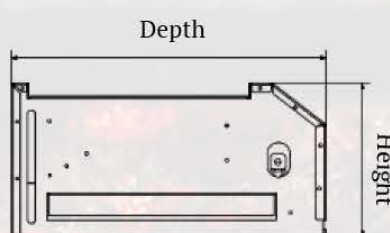
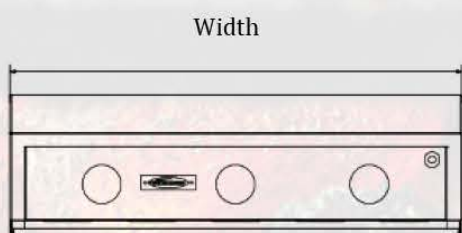





Jetmaster reserves the right to alter specifications, scope of supply and model line up without prior notification

# KALAHARI 2 IN 1

*Freestanding*

The Kalahari 2 in 1 Boma, designed for versatility and convenience. It features a sturdy, detachable, and collapsible exterior for easy transport and storage. Included are three reusable kebab sticks and a base plate for effortless cleanup, along with a nickel-plated grilling surface for optimal cooking. The Kalahari Boma is perfect for outdoor gatherings, offering both functionality and ease of use. Enjoy delicious grilled meals anywhere!



UNIT / MODEL	MEASUREMENTS (MM)			
	Width	Depth	Height	Grill Size
KHALAHARI 2 IN 1				
BOMA	477	500	452	440X440

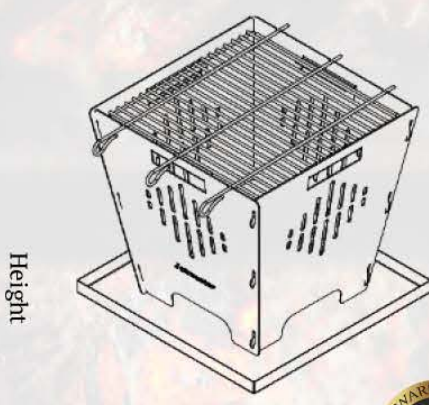
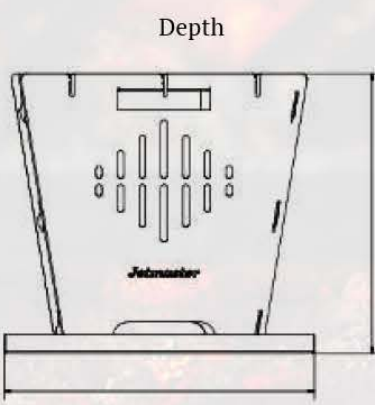
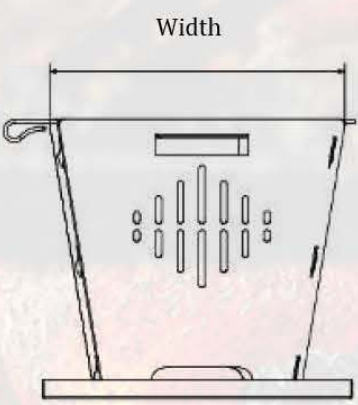



Jetmaster reserves the right to alter specifications, scope of supply and model line up without prior notification

# MOREMI

## Braai pit

The Moremi Braai Pit, a marvel of stainless steel artistry. Its outer body crafted from stainless steel, exudes strength and durability. The grill kit features an adjustable swivel lever, allowing for temperature control and perfect cooking for meats and potjiekos. The braaipit's versatile design allows for the removal of the grill, creating a true firepit experience.



UNIT / MODEL	MEASUREMENTS (MM)			
	Width	Height	Grill Max Extention Height	Grill Size
MOREMI	855Ø	403	420	545Ø

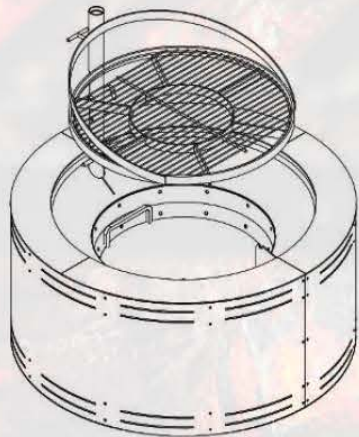
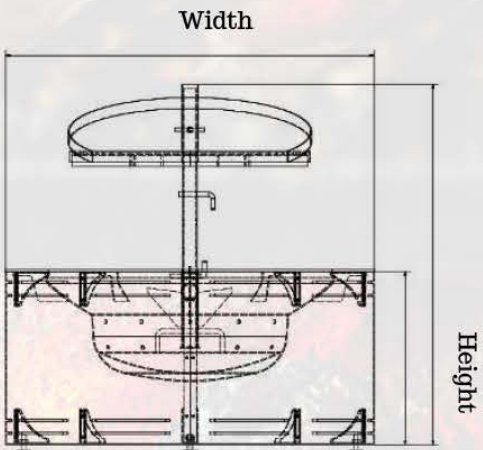



Jetmaster reserves the right to alter specifications, scope of supply and model line up without prior notification

# POTJIE COOKER

*Freestanding*

The Potjie Cooker, designed for 3 to 4 kg pots. Available for purchase with or without a pot, this cooker enhances your outdoor cooking experience. While some believe the secret to a great potjie is to leave it undisturbed, we know it's the bushveld setting and great company that truly make it special. Create the most delicious potjie in South Africa with our Potjie Cooker, perfect for gatherings and unforgettable culinary moments!



UNIT / MODEL	MEASUREMENTS (MM)			
	Width	Depth	Height	Grill Size
POTJIE COOKER	358	363	330	311X265

Width

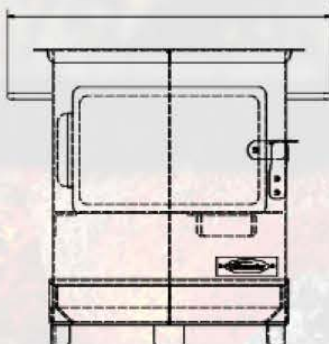

Depth

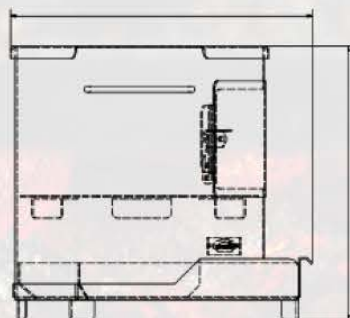

Grill Size

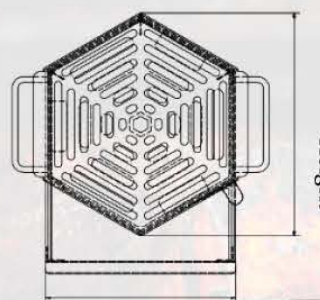

Height

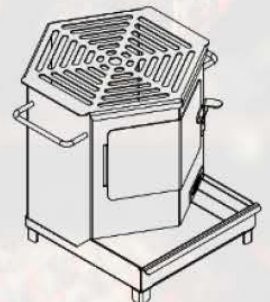



Jetmaster reserves the right to alter specifications, scope of supply and model line up without prior notification



# UNIVERSAL 850 LOW

*Built in or Freestanding*

The 850 Low with Alfresco Logpan, a sleek and versatile solution for your outdoor living space. This unit effortlessly combines the warmth of a fireplace with the functionality of a barbecue, giving you the best of both worlds. No construction, no hassle—just position your unit, light it up, and get grilling or unwind by the cosy flames. Whether you're hosting a lively gathering or enjoying a peaceful evening, this stunning centerpiece transforms your outdoor area into a place of comfort and enjoyment.

The 850 Low is available with or without a freestanding cabinet, allowing you to either set it up instantly or seamlessly integrate it into your built-in design. It's the perfect fit for any space, delivering a premium outdoor experience with none of the complications—just warmth, flavour, and style.



UNIT /MODEL	MEASUREMENTS (MM)						LOG STORAGE			FLUE SIZE	
	Width	Depth	Gather Height	Height	Height of flue with cowl	Grill Size	Width	Depth	Height	Ø	Length
FS CABINET	1235	506	-	1378	1425	-	1235	480	305	300	1200
850 LOW UNIT	850	460	272	680	1425	805 x 350	-	-	-	250	1200

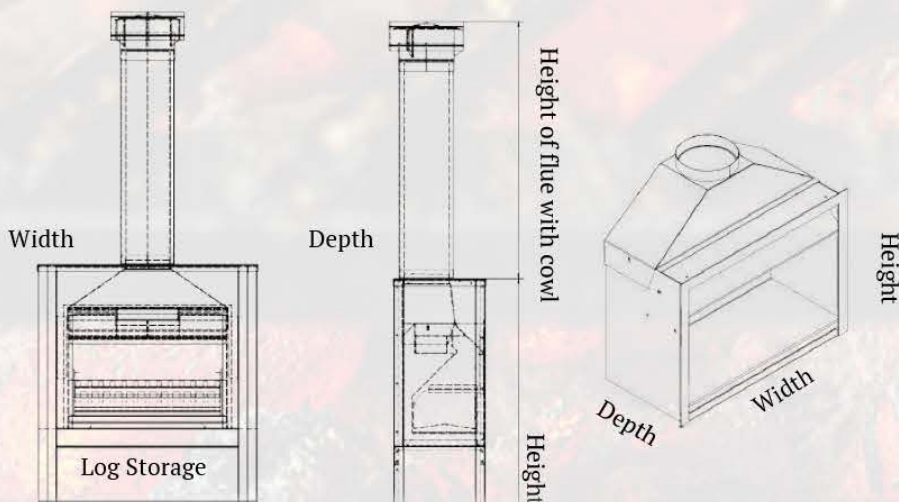

**MASTER**  
FIREPLACES

6 Larch Nook,  
Zwartkop Ext. 4, Centurion

082 477 6505  
www.masterfireplaces.co.za

Excludes Corrosion